

2017

Chloride Migration Variability in Reinforced Concrete Highway Structures in Pennsylvania

Connor Kane Bradley
Lehigh University

Follow this and additional works at: <http://preserve.lehigh.edu/etd>

 Part of the [Environmental Engineering Commons](#)

Recommended Citation

Bradley, Connor Kane, "Chloride Migration Variability in Reinforced Concrete Highway Structures in Pennsylvania" (2017). *Theses and Dissertations*. 2522.

<http://preserve.lehigh.edu/etd/2522>

This Thesis is brought to you for free and open access by Lehigh Preserve. It has been accepted for inclusion in Theses and Dissertations by an authorized administrator of Lehigh Preserve. For more information, please contact preserve@lehigh.edu.

Chloride Migration Variability in Reinforced Concrete Highway Structures in
Pennsylvania

by

Connor Kane Bradley

A Thesis

Presented to the Graduate and Research Committee

of Lehigh University

in Candidacy for the Degree of

Master of Science

in

Environmental Engineering

Lehigh University

May 2017

This thesis is accepted and approved in partial fulfillment of the requirements for the Master of Science.

Date

Thesis Advisor

Chairperson of Department

ACKNOWLEDGEMENTS

All of the work I accomplished would not have been possible without the guidance and assistance from Dr. Fox and Dr. Naito of Lehigh University's Department of Civil and Environmental Engineering. I would also like to acknowledge the Pennsylvania Department of Transportation for its support in the completion of experimental procedures and its financial support on this research initiative.

TABLE OF CONTENTS

List of Tables.....	vi
List of Figures.....	vii
Abstract.....	1
1. Background.....	3
2. Materials and Methods.....	6
2.1 NT Build 492 (Nordtest Method).....	6
2.1.1 Concrete Samples.....	6
2.1.2 Sample Preconditioning.....	7
2.1.3 Sample Testing.....	8
2.1.4 Measurement of Chloride Penetration.....	10
2.1.5 Determination of Non-Steady State Migration Coefficient D_{nssm} ...	11
2.2 Rapid Chloride Permeability Test - ASTM C1202, ASSHTO T277.....	12
2.2.1 Sample Testing.....	12
2.2.2 Sample Results.....	12
3. Results and Discussion.....	14
3.1 Comparison of NT Build 492 and Rapid Chloride Permeability Test Results.....	14
3.2 Comparison of Concrete Properties and Chloride Migration.....	15
3.3 Chloride Migration Variation within One State, Pennsylvania.....	18
4. Conclusion.....	28
References.....	30

LIST OF TABLES

Table 1. Voltage Adjustment Table.....	9
Table 2. Rapid Chloride Permeability Test Ratings.....	13
Table 3. Coarse Aggregate Rock Type Role in Chloride Migration Coefficient.....	20
Table 4. Chloride Migration Coefficient Variability by County.....	24

LIST OF FIGURES

Figure 1. 4” x 8” Concrete Cylinders and 50mm Thick Concrete Sample.....	6
Figure 2. Preconditioning Samples in the Vacuum.....	7
Figure 3. NT Build 492 Experimental Setup.....	8
Figure 4. Chloride Penetration Measurement and Example Image.....	10
Figure 5. Rapid Chloride Permeability Test Setup.....	12
Figure 6. Chloride Migration Coefficient and Coulombs Passed Comparison.....	14
Figure 7. Chloride Migration Coefficient vs. Entrained Air Percentage.....	16
Figure 8. Chloride Migration Coefficient vs. Percent Supplementary Cementitious Material.....	17
Figure 9. Chloride Migration Coefficient vs. Coarse Aggregate Absorption.....	19
Figure 10. Pennsylvania Geologic Variability.....	21
Figure 11. Coarse Aggregate Supplier Zip Code and Rock Type.....	22
Figure 12. Coarse Aggregate Supplier County: Minimum Chloride Migration Coefficient.....	23
Figure 13. Coarse Aggregate Supplier County: Maximum Chloride Migration Coefficient.....	23
Figure 14. Coarse Aggregate Supplier County Coulombs Passed Range – Minimum....	26
Figure 15. Coarse Aggregate Supplier County Coulombs Passed Range – Maximum....	26

ABSTRACT

To assess the potential design life for reinforced concrete highway infrastructure in the Northeastern United States, the resistance to corrosion must be known. Reinforced concrete structures in both cold and marine environments are exposed to chloride, an ion with the potential to migrate through concrete and corrode steel. Chloride content can be assessed relative to the chloride migration coefficient determined at an age of 28-days using methods defined in NT Build 492. This approach is a departure from traditional rapid chloride permeability testing methods used for qualification of concrete mix designs by state departments of transportation. To investigate the impact of these methods, a comprehensive experimental study of PennDOT qualified mixes was conducted. Each mix was procured from ongoing construction efforts in the state and subject to both NT Build 492 and ASTM C1202 (Rapid Chloride Permeability Test). The results show that chloride migration coefficient varies considerably throughout the state, from $0.545 \times 10^{-12} \text{ m}^2/\text{sec}$ to $17.24 \times 10^{-12} \text{ m}^2/\text{sec}$. The variation is in line with the results from Rapid Chloride Permeability Tests (RCPT) conducted on the same mixes. Results for NT Build 492 also correlated strongly with results for the RCPT, despite high coefficients of variability for both tests.

Chloride migration was also found to be related to the coarse aggregate used in the mix design as well as the coarse aggregate's absorption. Due to Pennsylvania's diverse geologic make-up, 9 different types of coarse aggregate were used in the 20 mix designs tested. Mixes using Diabase and Dolomite as coarse aggregates were the most resistive to chloride migration, while mixes containing Gravel and Limestone experienced poor

resistivity to chloride ingress. Coarse aggregate was sourced from 12 different counties in the mix designs tested. Results for NT Build 492 and the RCPT varied considerably in 5 of the counties.

1. BACKGROUND

Concrete is the world's primary building material and is used in most types of construction due to its flexible design and relative low cost. An estimated 25 billion metric tons of concrete are manufactured each year [1]. Concrete production at this magnitude carries with it a significant environmental impact. In 2002, 1.4% of the U.S. anthropogenic CO₂ emissions stemmed from the energy intensive production process of Portland cement, a primary constituent of many concrete mix designs [2-4]. The global focus on sustainability places a significant value on the development of concrete mix designs that will reduce the use of Portland cement and maximize a concrete construction's service life.

Concrete mix designs can be manipulated in many ways to attain desired properties. In 2008, the Pennsylvania Department of Transportation (PennDOT) and the concrete industry recognized the need for higher quality reinforced concrete (RC) bridge structures and pursued new mix design specifications. The primary objectives were to develop concretes with reduced shrinkage potential and enhanced permeability characteristics [5]. The traditional AAA concrete mix design was improved by decreasing the maximum water-cement ratio, setting a minimum requirement for compressive strength at 28 days, and recommending the "judicious" use of supplementary cementitious material (SCM) as pozzolan material in conjunction with Portland cement. Mixes that meet these specifications are designated as AAAP concrete [5].

A principal concern in RC structures is the susceptibility of the concrete to chloride ingress and the subsequent corrosion of the steel reinforcements. Concrete bridge decks are exposed to aggressive chloride environments in coastal marine areas and in cool climates

where they are subjected to chloride laden deicing salts [6]. Application of deicing salts has been confirmed to cause a decrease in the structural and serviceability reliabilities of concrete bridge decks [7]. Corrosion of steel reinforcements and the formation of corrosion products such as rust can result in internal micro-cracking, external cracking, and eventually spalling [8]. Identifying, maintaining, or replacing these structures requires testing and other potential high costs for repairs [9].

Capillary absorption, hydrostatic pressure, and diffusion are mechanisms by which chloride can migrate through concrete. The principle method of chloride ingress is diffusion, the movement of chloride ions under a concentration gradient [10, 11]. The variable nature of concrete mix design offers concrete producers many options to manipulate the materials used in an effort to maximize the concrete's resistivity to chloride ingress. Changes in the water-cement ratio, concrete age and degree of hydration, curing temperature, C_3A content, and use of SCM's have all been shown to affect concrete's resistance to chloride migration [10, 11]. Feng et al. show that the use of fly ash and blast furnace slag improves concrete's resistivity to chloride ingress [12]. The use of fly ash and blast furnace slag as supplementary cementitious material in concrete demonstrated a decrease in the diffusion coefficient of chloride ions. With a higher content of C_3A , concretes with fly ash and blast furnace slag additives can form more chloride absorbing Friedel's salt ($C_3A \cdot CaCl_2 \cdot 10H_2O$) [12]. Concrete's age can also influence the chloride penetration rate; as concrete ages and the subsequent degree of hydration increases, the internal pore matrix becomes more developed and eliminates potential paths for diffusion [10-12].

The rate of chloride ion diffusion through different concretes, while varied, is still extremely small. The study and determination of the steady state chloride diffusion for a particular mix design would take years. As such, the concrete industry developed and standardized several short term procedures to determine non-steady-state rates of chloride ingress that could be used to approximate a concrete's resistance to chloride migration. Due to the many mechanisms by which chloride ions can migrate through concrete, each test has drawbacks due to varying preconditioning methods and experimental procedures [10]. Using the results from multiple tests gives one a better idea of a concrete's resistance to chloride migration in the field.

Isolating and optimizing particular aspects of a concrete mix design to improve the concrete's resistivity to chloride migration would prove to be extremely valuable. Increasing a concrete's service life will diminish the need for future concrete production, reducing future spending and carbon emissions through cement manufacturing. States that utilize a broad range of SCM's and coarse aggregate types may experience high variability in their RC structures. Identifying the mix design components that drive these variations in concrete's chloride resistance can be used to develop more resistive structures in the future with longer service lives.

2. MATERIALS AND METHODS

2.1 NT Build 492

2.1.1 Concrete Samples

Following the casting of AAAP concrete bridge decks at PennDOT construction sites, three 4" x 8" cylinders in accordance with ASTM C31 are sealed and shipped to Lehigh University [13]. Upon arrival at Lehigh University's campus in Bethlehem, PA, the concrete cylinders are documented and placed in a water curing tank maintaining a constant temperature of 25°C. 27 days after fabrication, 50 ± 2 mm thick samples are cut from each of the cylinders using a water cooled diamond saw blade as shown in Figure 1. Samples are then washed of excess material and dried.



Figure 1. 4" x 8" Concrete Cylinders and 50mm Thick Concrete Sample

2.1.2 Sample Preconditioning

After cutting, samples are placed under a vacuum for 3 hours. The vacuum chamber must maintain a pressure of less than 50 mbar (5 kPa) [14]. The vacuum chamber is then flooded with a saturated $\text{Ca}(\text{OH})_2$ solution until the concrete samples are fully submerged as shown in Figure 2.

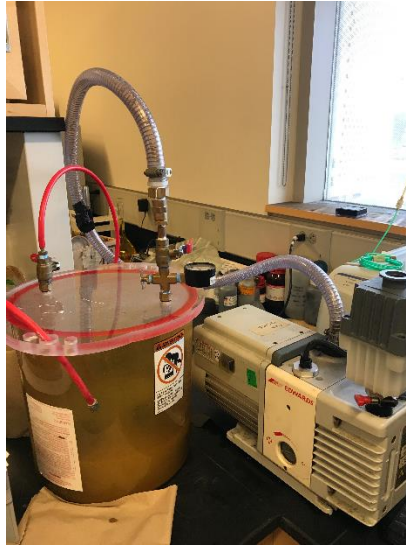

Figure 2. Preconditioning Samples in the Vacuum

Samples remain in the vacuum sealed solution for an additional hour. The vacuum is then depressurized and the samples soak in the solution under atmospheric pressure for an additional 18 ± 2 hours.

2.1.3 Sample Testing

After preconditioning, samples are rinsed with deionized water, air dried, and tightly sealed in a rubber sleeve exposing only the top and bottom face. The sample is placed on an inclined support with the bottom face exposed to a 10% NaCl catholyte solution (by mass) and the top face exposed to a 0.3 N NaOH anolyte solution. Figure 3 illustrates the experimental set up.

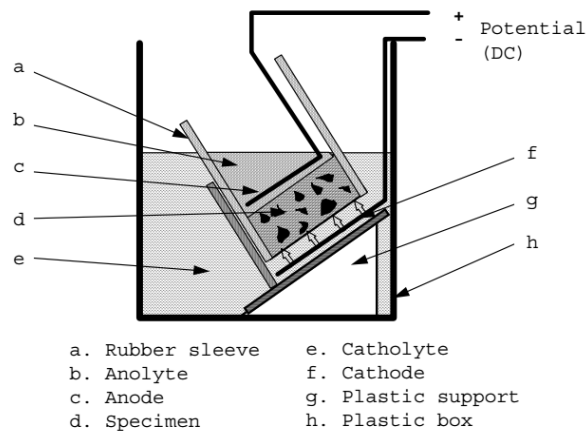

Figure 3. Migration Test Experimental Setup [14]

The anode and cathode of each sample are connected to a power source and initially subjected to 30V. The corresponding current is measured and Table 1 is used to determine if a voltage adjustment is required, followed by the necessary testing duration. The initial and final voltage, current, and anolyte solution temperature are recorded.

Table 1. Voltage Adjustment Table [14]

Initial current I_{30V} (with 30 V) (mA)	Applied voltage U (after adjustment) (V)	Possible new initial current I_o (mA)	Test duration t (hour)
$I_o < 5$	60	$I_o < 10$	96
$5 \leq I_o < 10$	60	$10 \leq I_o < 20$	48
$10 \leq I_o < 15$	60	$20 \leq I_o < 30$	24
$15 \leq I_o < 20$	50	$25 \leq I_o < 35$	24
$20 \leq I_o < 30$	40	$35 \leq I_o < 40$	24
$30 \leq I_o < 40$	35	$40 \leq I_o < 50$	24
$40 \leq I_o < 60$	30	$50 \leq I_o < 60$	24
$60 \leq I_o < 90$	25	$60 \leq I_o < 75$	24
$90 \leq I_o < 120$	20	$75 \leq I_o < 80$	24
$120 \leq I_o < 180$	15	$80 \leq I_o < 90$	24
$180 \leq I_o < 360$	10	$90 \leq I_o < 120$	24
$I_o \geq 360$	10	$I_o \geq 120$	6

2.1.4 Measurement of Chloride Penetration

When the test is complete, power is shut off and the samples are removed from the experimental apparatus, rinsed, dried, and split axially into two pieces. One cross sectional piece from each sample is sprayed with 0.1 M Silver Nitrate solution. After 15 minutes, a white silver chloride precipitate will be clearly visible indicating the chloride penetration profile. Using a slide caliper, measurements of chloride penetration are made in 10mm increments across the 100mm diameter of the sample. Five measurements accurate to 0.1mm are required to accurately determine the non-steady-state migration coefficient.

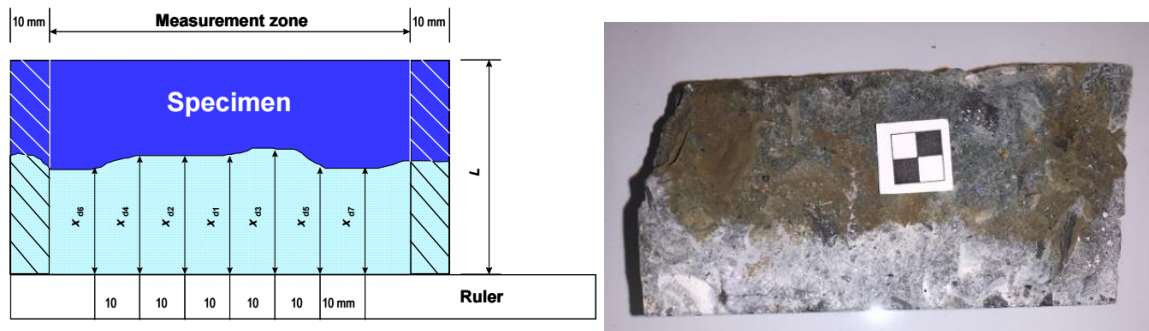

Figure 4. Chloride Penetration Measurement [14] and Example Image

2.1.5 Determination of Non-Steady State Migration Coefficient D_{nssm}

The non-steady-state migration coefficient, D_{nssm} , can be determined using Equation (1). The D_{nssm} is typically reported in units of 10^{-12} m²/sec. Concrete's with a low values for D_{nssm} exhibit high resistivity to chloride ion migration.

$$D_{nssm} = \frac{RT}{zFE} \cdot \frac{x_d - \alpha\sqrt{x_d}}{t} \quad (1)$$

Where:

$$E = \frac{U-2}{L} \quad (2)$$

$$\alpha = 2\sqrt{\frac{RT}{zFE}} \cdot \text{erf}^{-1} \left(1 - \left(\frac{2c_d}{c_0} \right) \right) \quad (3)$$

D_{nssm} : non-steady-state migration coefficient, m²/s;

z : absolute value of ion valence, for chloride, $z = 1$;

F : Faraday Constant, $F = 9.648 \times 10^4$ J/(V·mol);

U : absolute value of the applied voltage, V;

R : gas constant, $R = 8.314$ J/(K·mol);

T : average value of initial and final temperature of anolyte solution, K;

L : thickness of specimen, m;

x_d : average value of penetration depths, m;

t : test duration, seconds;

erf^{-1} : inverse of error function;

c_d : chloride concentration at which the color changes, $c_d \approx 0.07$ N for OPC concrete;

c_0 : chloride concentration in catholyte solution, $c_0 \approx 0.2$ N.

2.2 Rapid Chloride Permeability Test – ASTM C1202, ASSHTO T277

2.2.1 Sample Testing

In conjunction with the determination of the non-steady-state migration coefficients of the bridge deck samples, PennDOT conducted the Rapid Chloride Permeability Test (RCPT) for each sample in accordance with ASTM C1202 standards [15]. At 56 days of age, three concrete samples are prepared with one face exposed to a 3% NaCl solution (by mass) and the other face exposed to a 0.3 N NaOH solution as shown in Figure 5. The samples are subjected to an electric potential of 60V for 6 hours.

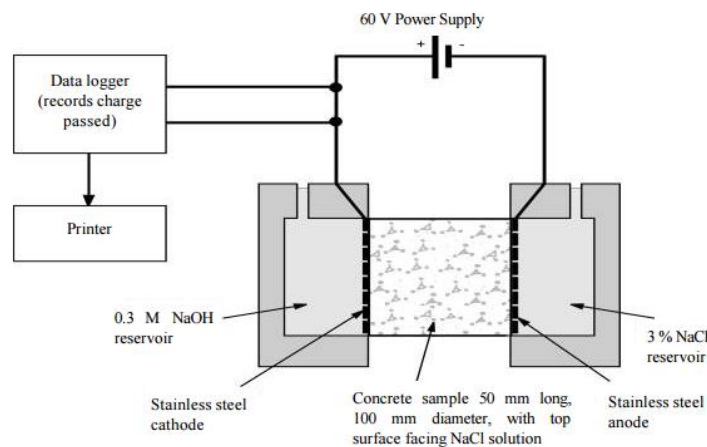

Figure 5. Rapid Chloride Permeability Test Setup [15, 16]

2.2.2 Sample Results

The total ionic movement over the course of the testing time is determined and the results are expressed as *Coulombs Passed*. It is important to note that the movement of other ions in addition to chloride affect the test result [10]. Table 1 shows how the test results are translated to a concrete's susceptibility to chloride ion penetration.

Table 2. Rapid Chloride Permeability Test Ratings [15]

Charge Passed (coulombs)	Chloride Ion Penetrability
> 4,000	High
2,000 – 4,000	Moderate
1,000 – 2,000	Low
100 – 1,000	Very Low
< 100	Negligible

3. RESULTS AND DISCUSSION

3.1 Comparison of Chloride Migration Coefficient and Coulombs Passed Results

Research is ongoing to better understand the relationship of different tests that assess how resistive concrete is to chloride ingress. Almost all conditions of NT Build 492 and RCPT procedures differ, yet both experiments are designed to isolate and accelerate the transport of chloride ion migration through concrete via diffusion. 13 of the mix designs tested at Lehigh University have corresponding RCPT results from PennDOT. Figure 6 shows a strong positive linear trend between the two tests: as the 28 day chloride migration coefficient result rises, so too does the anticipated result for coulombs passed at 56 days of age. Higher values for both tests suggest the concrete will have poor resistivity to chloride ingress.

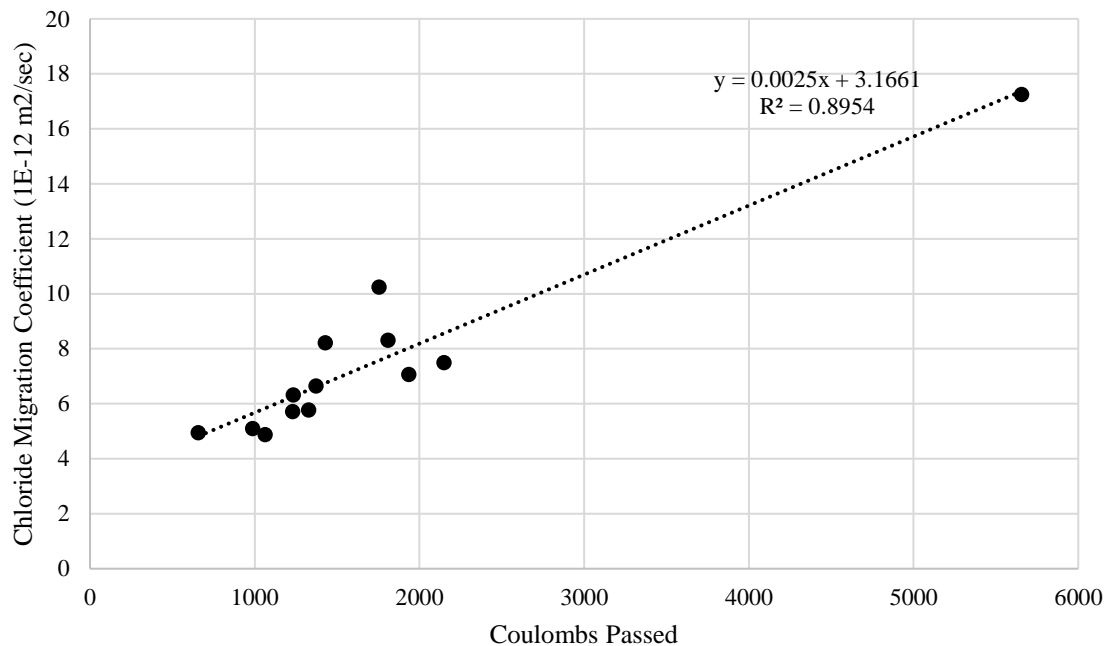

Figure 6. Chloride Migration Coefficient and Coulombs Passed Comparison

It is important to note that the RCPT has been the subject of criticism due to its relatively high variability of results and the heating of the specimen that occurs as it is subjected to 60V for 6 hours [17, 18]. The coefficient of variability of the RCPT results ranged from 1.42% to 13.12% with an average coefficient of variation of 5.76%. Comparatively, results for NT Build 492 varied more. NT Build 492's coefficient of variability ranged from 0.46% to 34.66% with an average coefficient of variation of 11.22%. McGrath and Hooton attempted to improve the RCPT by reducing the duration of the experiment from 6 hours to 30 minutes. Shortening the RCPT did not improve its correlation to other test results [17].

3.2 Comparison of Concrete Properties and Chloride Migration

Fluctuations in outside temperature and moisture, short and long term internal chemical reactions, and the subsequent pore geometry in concrete all play a role in chloride migration and chloride penetration rates into concrete [17]. Figure 7 shows how the chloride migration coefficient varies based on the concrete's entrained air percentage. While there are many other characteristics that vary within the tested concrete mixes besides entrained air percentage, Figure 7 does display some correlation between the two variables. Overall, as entrained air percentage increases, so too does the chloride migration coefficient. This result makes sense, as concretes with a higher volumetric air content have more pathways that chloride can easily migrate through.

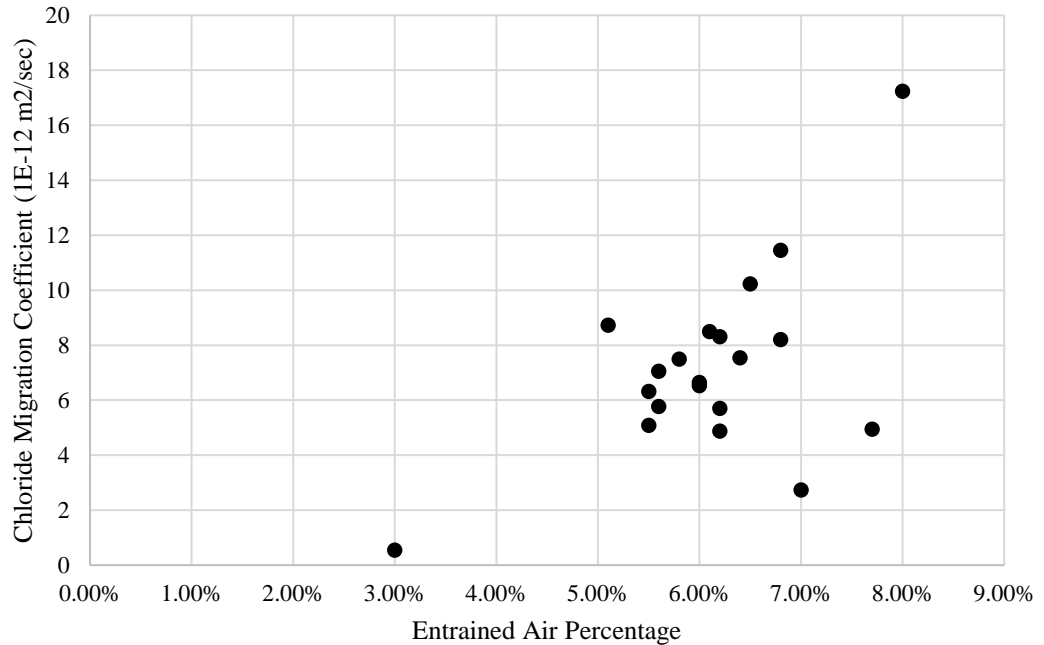

Figure 7. Chloride Migration Coefficient vs. Entrained Air Percentage

Fly ash, blast furnace slag, and silica fume are industrial by-products used as SCM's due to their pozzolan properties. The use of SCM's is incentivized as it reduces the need for expensive cement that contributes to greenhouse gas emissions during its production. 15 of the 20 mix designs tested implemented fly ash, blast furnace slag, silica, or masonry mortar as SCM that ranged from 19.69% to 68.2% of total pozzolan material. Most of the mix designs tested incorporated blast furnace slag. Figure 8 shows how the chloride migration coefficients vary in response to changes in the SCM percentage of pozzolan material in the mix design.

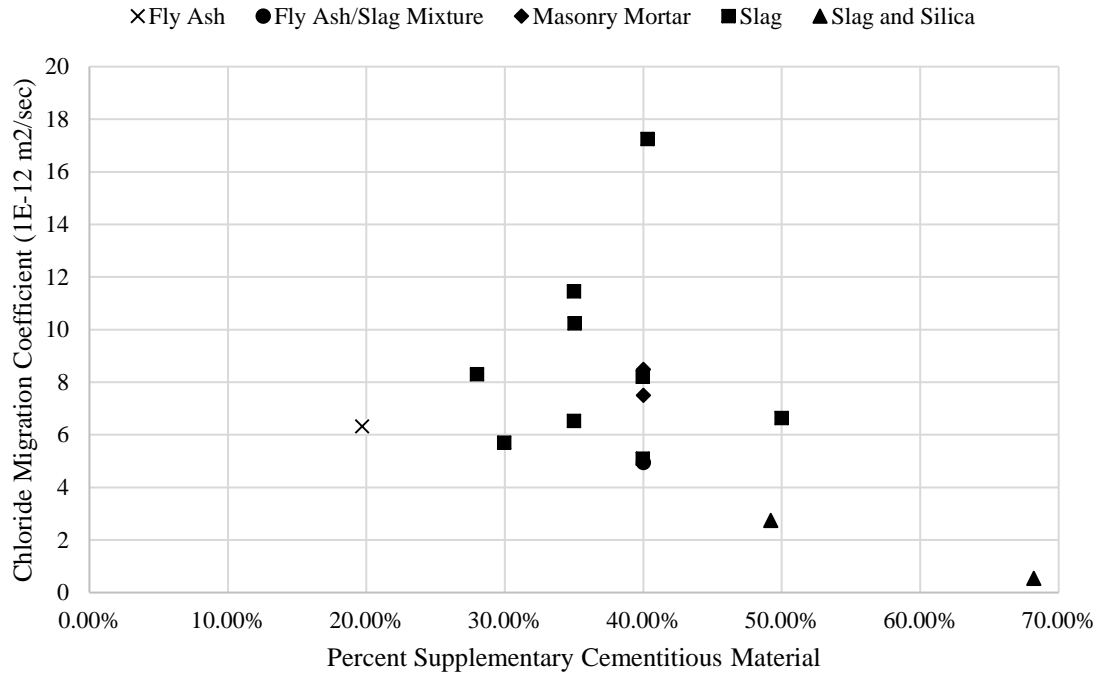

Figure 8. Chloride Migration Coefficient vs. Percent Supplementary Cementitious Material

The expected trend is as the percent of SCM increases, the corresponding chloride migration coefficient should decrease. However, no clear trend emerges. Again, it is important to note that many other variables differ in the separate concretes along with percent SCM.

There are documented benefits of incorporating fly ash and slag as pozzolan material. Thomas and Bamforth have shown that the incorporation of both fly ash and slag have little impact on transport properties at early ages. However, after a few years, the use of fly ash and slag as supplementary cementitious materials proved to limit the rate of chloride ingress by orders of magnitude of difference [12, 19].

3.3 Chloride Migration Variation within One State, Pennsylvania

Coarse aggregate is the principle contributor to the volume of concrete. The coarse aggregate's potential to absorb water is suspected to play a role in chloride ion diffusivity in concrete. Coarse aggregate absorption (ABS) is defined as the increase in weight (%) of aggregate due to water infiltrating the pores, ignoring water adhered to the surface. As chloride ions have the potential to migrate through both the coarse aggregate and cement paste, the relationship between coarse aggregate type, ABS, and chloride migration coefficient was investigated [20, 21]. Figure 9 compares the ABS of the different coarse aggregates present in the concrete samples tested to their chloride migration coefficient results. Data on the coarse aggregate ABS was determined using the concrete mix designs provided by the concrete producers coupled with PennDOT's Bulletin 14. With the coarse aggregate supplier code, Bulletin 14 provides information on the coarse aggregates specific gravity, ABS, sodium sulfate percentage, and rock type.

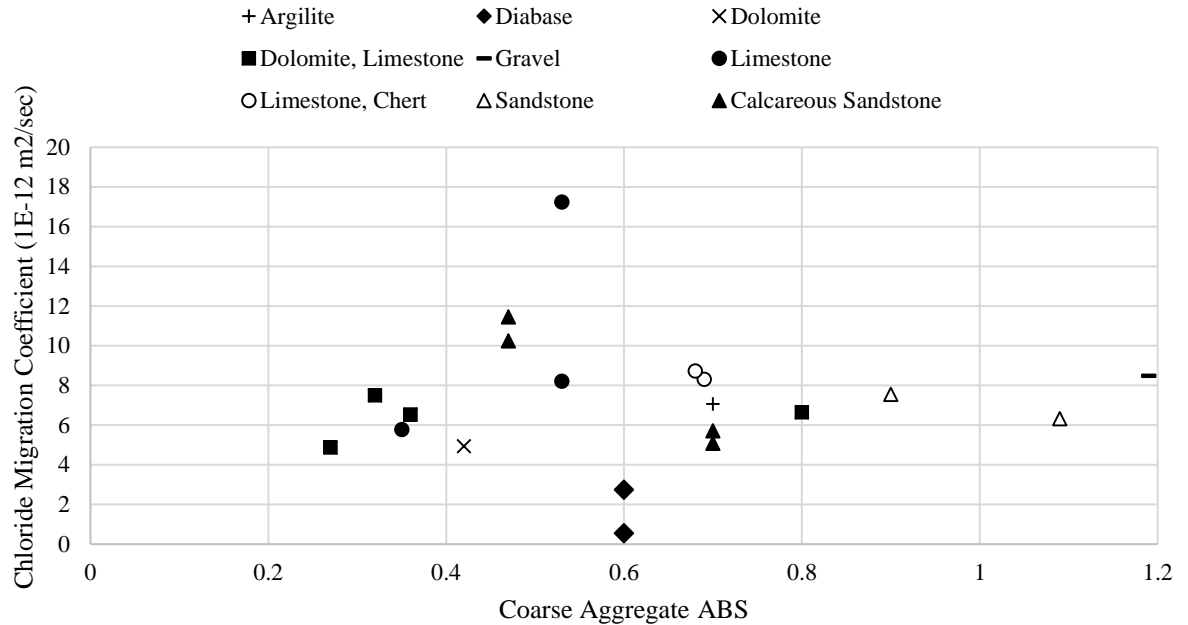

Figure 9. Chloride Migration Coefficient vs. Coarse Aggregate Absorption

The coarse aggregate ABS ranged from 0.27 to 1.19 for the concrete samples tested in the study. Figure 9 shows that coarse aggregates with similar ABS values had similar chloride migration coefficient results. This trend is observed in concretes with coarse aggregates of Diabase, a mixture of Dolomite/Limestone, and Calcareous Sandstone. Limestone stands out as an exception.

Table 3 complements Figure 9, and is grouped by the different coarse aggregate rock types, their average chloride migration coefficient, the variance of the chloride migration coefficients (if the coarse aggregate was present in more than one mix design), and their average coarse aggregate absorption for each rock type. The results indicate that there is no correlation between coarse aggregate ABS and the concrete's corresponding chloride migration coefficient. Diabase and Dolomite stood out as being more resistive to

chloride ingress than other rock types. The concrete mixes containing both Dolomite and Limestone coarse aggregate also had a consistently low chloride migration coefficient. Limestone, Limestone and Chert, and Gravel displayed the highest average chloride migration coefficients. The highest chloride migration coefficient determined, $17.24 \times 10^{-12} \text{ m}^2/\text{sec}$, contained limestone as the coarse aggregate.

Table 3. Coarse Aggregate Rock Type Role in Chloride Migration Coefficient

Rock Type	Avg. Chloride Migration Coefficient (1E-12 m ² /sec)	Variance of Chloride Migration Coefficient	Mix Designs Tested	Avg. Coarse Aggregate ABS	Variance of ABS
Diabase (DI)	1.6425	2.41	2	0.6	0
Dolomite (DO)	4.94	-	1	0.42	-
Dolomite, Limestone (DO, LS)	6.38	1.20	4	0.44	0.060
Sandstone (SS)	6.93	0.75	2	1.00	0.018
Argilite (AR)	7.06	-	1	0.70	-
Calcareous Sandstone (CSS)	8.12	10.21	4	0.59	0.018
Gravel (GL)	8.49	-	1	1.19	-
Limestone, Chert (LS, CH)	8.52	0.088	2	0.69	5E-5
Limestone (LS)	10.41	36.51	3	0.47	.011

Figures 10-15 were developed using the ERSI ArcMAP program.

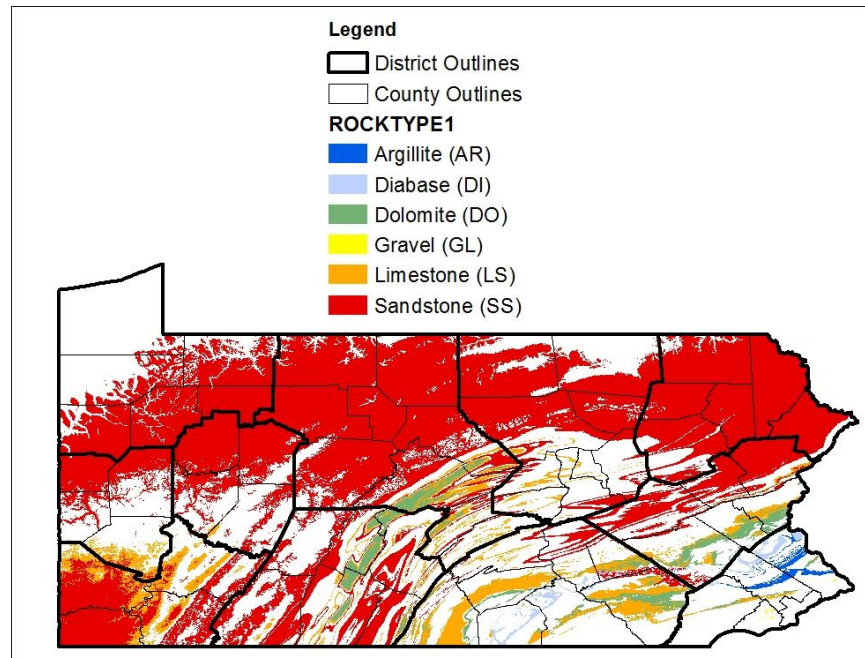

Figure 10. Pennsylvania Geologic Variability (USGS)

Figure 10 displays USGS data of Pennsylvania's geologic make-up. The six rock types shown are the rock types present as coarse aggregate in the concrete mix designs tested. Northern Pennsylvania is mainly comprised of sandstone, yet the geologic formations in southern Pennsylvania are highly variable. Using PennDOT's Bulletin 14 and Bulletin 14 List, it is possible to pair up the coarse aggregate suppliers and what rock type they are exporting. This data is displayed in Figure 11.

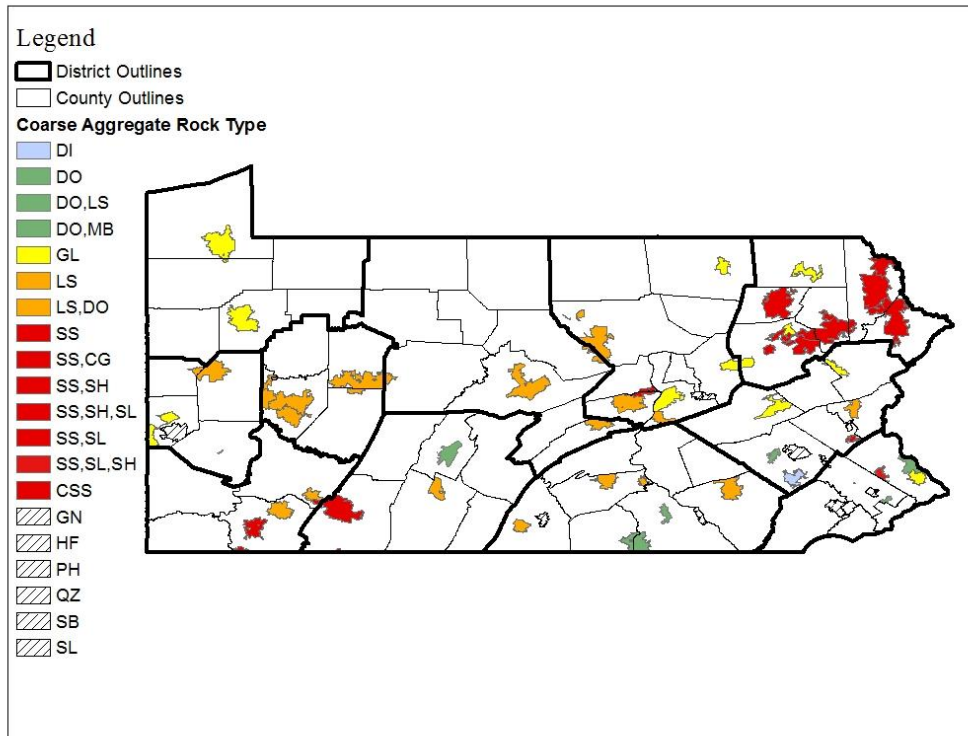

Figure 11. Coarse Aggregate Supplier Zip Code and Rock Type

Figure 11 illustrates the diversity of coarse aggregates used throughout the state. Limestone, Gravel, and mixtures of Sandstone coarse aggregate are exported from much of central and northern Pennsylvania. More variability is seen in the south and southeastern sectors of the state where Dolomite and Diabase are also exported.

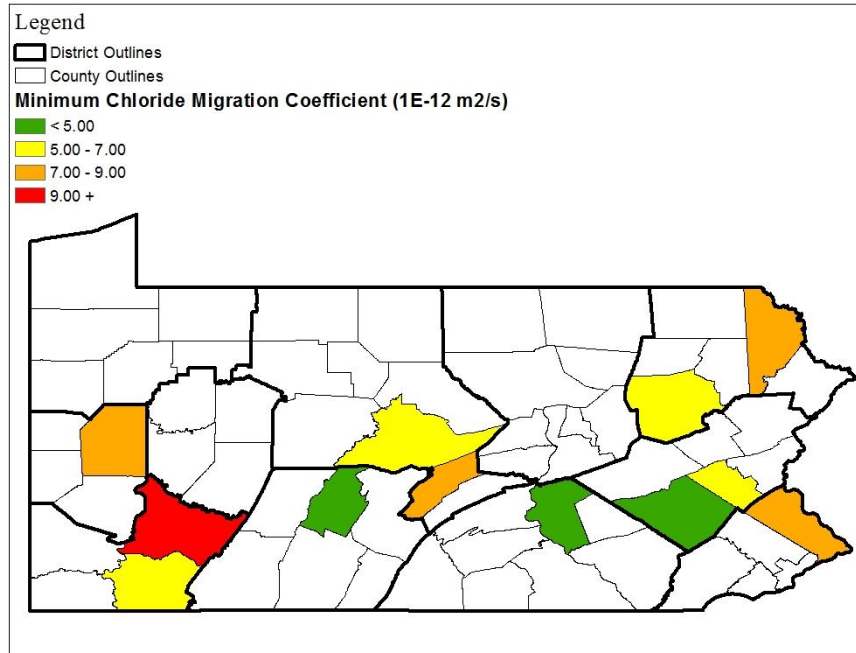

Figure 12. Coarse Aggregate Supplier County: Minimum Chloride Migration Coefficient

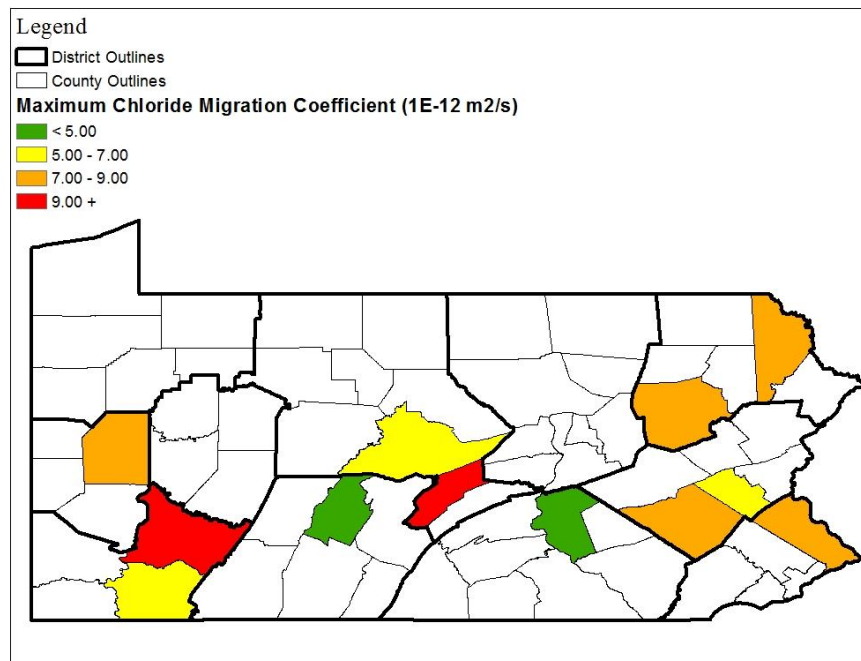

Figure 13. Coarse Aggregate Supplier County: Maximum Chloride Migration Coefficient

Figures 12-13 are maps indicating the source county of the coarse aggregate used in the concrete mix designs and the minimum and maximum chloride migration coefficients that were determined. Figures 12-13 are complemented by Table 4. Table 4 is grouped by each county that served as a source of coarse aggregate used in the concretes tested. The table shows the county name, average and variance of the chloride migration coefficient (if there was more than one), and the minimum and maximum chloride migration coefficient result.

Table 4. Chloride Migration Coefficient Variability by County

County	Avg. Chloride Migration Coefficient (1E-12 m ² /sec)	Variance of Chloride Migration Coefficient	Mix Designs Tested	Minimum Chloride Migration Coefficient (1E-12 m ² /sec)	Maximum Chloride Migration Coefficient (1E-12 m ² /sec)
Berks	3.59	112.62	3	0.545	7.50
Blair	4.94	-	1	4.94	4.94
Bucks	7.06	-	1	7.06	7.06
Butler	8.52	0.09	2	8.31	8.73
Centre	6.21	0.37	2	5.78	6.64
Dauphin	4.87	-	1	4.87	4.87
Fayette	5.40	0.19	2	5.09	5.71
Lehigh	6.53	-	1	6.53	6.53
Luzerne	7.41	2.35	2	6.32	8.49
Mifflin	12.73	40.81	2	8.21	17.24
Wayne	7.55	-	1	7.55	7.55
Westmoreland	10.85	0.75	2	10.24	11.46

Among the 20 concretes tested, coarse aggregates came from 12 different counties. 7 counties were sources of coarse aggregate for more than one concrete mix design tested. Of those seven, Mifflin and Berks County had the most variable results for the chloride migration coefficient. Luzerne also experienced variability, though to a lesser degree.

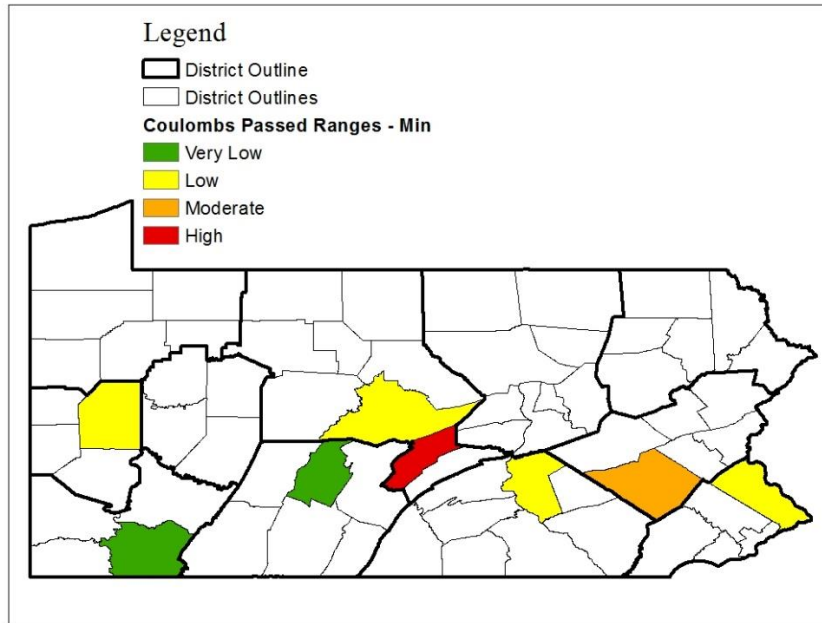

Figure 14. Coarse Aggregate Supplier County Coulombs Passed Range - Minimum

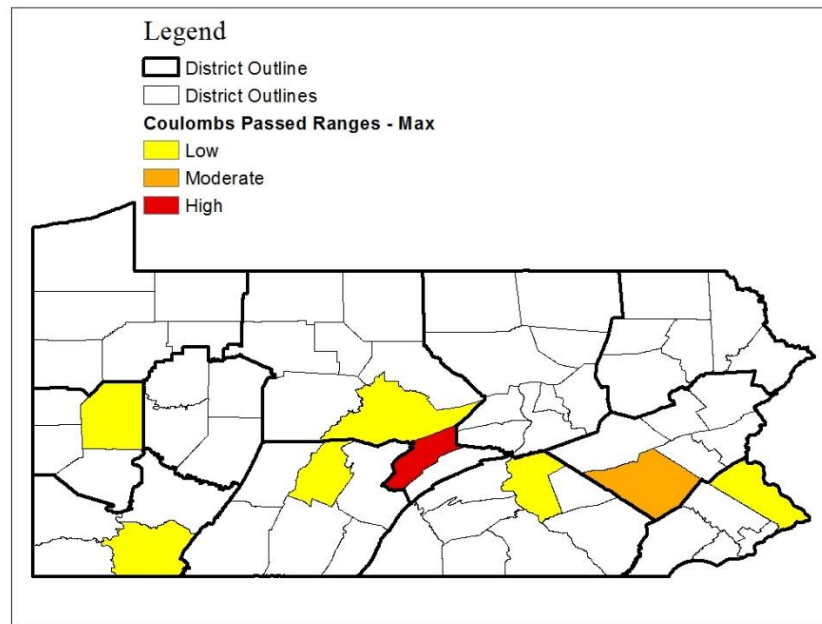

Figure 15. Coarse Aggregate Supplier County Coulombs Passed Range - Maximum

Figures 14-15 are maps indicating the source county of the coarse aggregate used in the concretes tested and the corresponding minimum and maximum results for Coulombs Passed from the RCPT. The Coulombs Passed ranges for “Very Low”, “Low”, “Moderate”, and “High” can be found in Table 2. Fayette and Blair County exhibit variance in the RCPT results in Figure 14 and Figure 15. The results from the RCPT show variability from different counties in Pennsylvania compared to the chloride migration coefficient results.

4. CONCLUSION

An experimental study was conducted to examine the variation in chloride resistance of concrete used in the state of Pennsylvania for state highway construction. 20 mixes were examined to determine the chloride migration coefficient and coulombs passed. The following conclusions can be made based on the observations presented:

- There exists a strong linear trend between results from NT Build 492 and the Rapid Chloride Permeability Test.
- Results from both NT Build 492 and the Rapid Chloride Permeability Test exhibit significant variability among the same concrete samples.
 - The coefficient of variability of the RCPT results ranged from 1.42% to 13.12% with an average coefficient of variation of 5.76%. Comparatively, the coefficient of variability for NT Build 492 results ranged from 0.46% to 34.66% with an average coefficient of variation of 11.22%.
- Resistance to chloride migration in reinforced concrete bridge decks in Pennsylvania varies considerably. NT Build 492 results for the chloride migration coefficient varied from $0.545 \times 10^{-12} \text{ m}^2/\text{sec}$ to $17.24 \times 10^{-12} \text{ m}^2/\text{sec}$. RCPT results for Coulombs Passed ranged from 924 to 5829.
- It cannot be determined if the percent of SCM influences concrete's resistance to chloride migration at young ages (28 days). There existed too much variability in other aspects of the mix design in the concretes tested to justify a direct comparison between them.
- Pennsylvania has a diverse geologic make-up, resulting in high variability in the

coarse aggregate rock types and the coarse aggregate ABS used in concrete mix designs throughout the state.

- Concrete samples with the same coarse aggregate rock types with similar ABS values exhibited similar results for chloride migration coefficient.
- Mix designs with coarse aggregate rock types of Diabase and Dolomite exhibited the most resistance to chloride ion penetration. Concretes containing coarse aggregates of Gravel and Limestone were the most susceptible to chloride ion penetration.
- Of the 12 Pennsylvania counties that exported coarse aggregate used in the concrete mixes tested, significant variability in results for the NT Build 492 and Rapid Chloride Permeability Test was experienced in 5 counties.

REFERENCES

- [1] (2009). "Recycling Concrete." The Cement Sustainability Initiative. <http://www.wbcscement.org/pdf/CSI-RecyclingConcrete-FullReport.pdf>
- [2] (2005). Van Oss, Hendrik. "Background Facts and Issues Concerning Cement and Cement Data." United States Geological Survey. <https://pubs.usgs.gov/of/2005/1152/2005-1152.pdf>
- [3] (2012). "Concrete CO₂ Fact Sheet." National Ready Mixed Concrete Association. <https://www.nrmca.org/sustainability/CONCRETE%20CO2%20FACT%20SHEET%20FEB%202012.pdf>
- [4] Shi, X., Xie, N., Fortune, K., Gong, J. (2012). "Durability of steel reinforced concrete in chloride environments: An overview." *Construction and Building Materials*, 30, 125-138.
- [5] "The AAAP Bridge Deck Concrete Initiative." Pennsylvania Aggregates and Concrete Association. <http://www.aaapconcrete.org/media/docs/AAAPFinalReport.pdf>
- [6] Stewart, M. G., and Rosowsky, D. V. (1998). "Time-dependent reliability of deteriorating reinforced concrete bridge decks." *Structural Safety*, 20(1), 91–109.
- [7] Stewart, M. G., and Rosowsky, D. V. (1998). "Structural Safety and Serviceability of Concrete Bridges Subject to Corrosion." *Journal of Infrastructure Systems*, 4(4), 146–155.
- [8] Vu, K. A. T., and Stewart, M. G. (2000). "Structural reliability of concrete bridges including improved chloride-induced corrosion models." *Structural Safety*, 22(4), 313–333.
- [9] Dunker, K. F., and Rabbat, B. G. (1993). "Why America's Bridges are Crumbling." *Scientific American*, 266(3), 66–72.
- [10] Standish, K., Hooton, R., and Thomas, M. (1997). "Testing the Chloride Penetration Resistance of Concrete: A Literature Review." Federal Highway Administration. University of Toronto.
- [11] Ahmad, A. and Kumar, Anil. "Chloride ion migration/diffusion through concrete and test methods." *International Journal of Advanced Scientific and Technical Research*. Issue 3, Vol 6. 2013.
- [12] Leng, F., Feng, N., and Lu, X. (2000). "An experimental study on the properties of resistance to diffusion of chloride ions of fly ash and blast furnace slag concrete." *Cement and Concrete Research*, 30(6), 989–992.
- [13] ASTM C31/C 31M. "Standard Practice for Making and Curing Concrete Test Specimens in the Field." ASTM International. West Conshohocken, PA.
- [14] NT Build 492 (1999). "Nordtest Method Concrete, Mortar and Cement Based

Repair Materials: Chloride Migration Coefficient from Non-Steady-State Migration Experiments.” Nordic Council of Ministers, Espoo, Finland.

- [15] ASTM C1202-12 (2012). “Standard Test Method for Electrical Indication of Concrete’s Ability to Resist Chloride Ion Penetration.” ASTM International. West Conshohocken, PA.
- [16] AASHTO T 277-07. (2011). “Standard Method of Test for Electrical Indication of Concrete’s Ability to Resist Chloride Ion Penetration.” American Association of States Highway and Transportation Officials, Washington, DC, 13pp.
- [17] McGrath, P. F., and Hooton, R. (1999). “Re-evaluation of the AASHTO T259 90-day salt ponding test.” *Cement and Concrete Research*, 29(8), 1239–1248.
- [18] Mobasher, B. and Mitchell, T.M. (1998). “Laboratory Experience with the Rapid Chloride Permeability Test.” *American Concrete Institute*, SP-108: Permeability of Concrete.
- [19] Thomas, M. and Bamforth, P. (1999). “Modelling chloride diffusion in concrete. Effect of fly ash and slag.” *Cement and Concrete Research*, 29, 487-495.
- [20] Hobbs, D. (1999). “Aggregate influence on chloride ion diffusion into concrete.” *Cement and Concrete Research*, 29 (12), 1995–1998.
- [21] Page, C.L., Lambert, P., Vassie, P.R.W. (1991). “Investigations of reinforcement corrosion. The pore electrolyte phase in chloride-contaminated concrete, *Materiaux et Constructions*, 24, 243-252.

VITA

Connor Bradley was born in Stamford, CT on March 9th, 1994 to Christopher Francis Bradley and Jeanne Mari Bradley. Connor earned a Bachelor of Science degree in Environmental Engineering at Lehigh University in May, 2016. After graduating with highest honors and earning Lehigh's Presidential Scholarship, Connor is now pursuing a Master of Science degree in Environmental Engineering at Lehigh University where he also served as a Research Assistant under Dr. John Fox. Following the completion of his Master's degree in May, 2017, Connor will begin work for an environmental consulting firm in Massachusetts.